

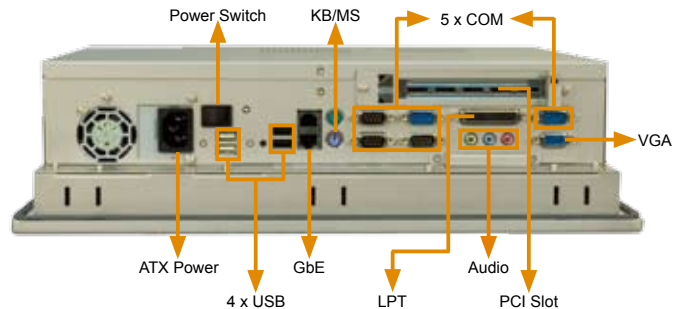



PPC-5150GS *Pentium® 4 / Celeron® D Panel PC with 15" TFT LCD and Touchscreen*



Features

1. Most popular panel PC form factor
2. High performance Intel® Pentium® 4 / Celeron® CPU support
3. DDR memory DIMM support up to 2GB
4. Pentium® 4/ Celeron® D industrial main board
5. Easy installing and mechanism design
6. High brightness 15" industrial grade panel
7. IP 65 compliant aluminum die-casting front panel

Specifications

Model	 PPC-5150GS	 PPC-5150A-9455 
CPU	Socket 478 Intel® Pentium® 4 or Celeron® D with a 533 MHz (max.) FSB	LGA 775 Intel® Core™2 Duo, Pentium® D, Pentium® 4 or Celeron® D with a 1066/667/800/533 MHz FSB
Chipset	Intel® 852GME + ICH5	Intel® 945G + ICH7
Memory	2 x 2 GB (max.) 333/266 MHz DDR DIMM	2 x 2 GB (max.) DDR2 DIMM (system max. 4 GB)
VGA	Intel® 852GME supports dual display	Intel® 945G supports dual display
SSD	CF Type II	CF Type II
Drive Bay	1 x 2.5" SATA/IDE HDD bay with anti-shock (or two 2.5" SATA/IDE HDD bays without anti-shock) 1 x Slim Type CD-ROM bay 1x Slim Type FDD bay	1 x 2.5" SATA HDD bays with anti-shock 1 x Slim Type CD-ROM bay
Ethernet	2 x Realtek RTL8110S Gigabit Ethernet controller	2 x Broadcom BCM5787M PCIe GbE chipsets with ASF2.0 remote control support
Audio	AC '97 2.3 Realtek ALC655	HD Audio Realtek ALC883
I/O	- 1 x RS-232/422/485 - 4 x RS-232 - 6 x USB 2.0 - 2 x PS/2 (KB/MS) - 1 x LPT - 1 x VGA out - 2 x LAN - 3 x Audio (Lin-in, Line-out, MIC-in) - 2 x IDE - 2 x SATA	- 4 x RS-232 - 1 x RS-232/422/485 - 1 x VGA - 1 x Print - 2 x LAN - 4 x USB - 3 x Audio (Line-in, Line-out, Mic-in)
Expansion Slot	1 x PCI slot	1 x PCI slot, 1 x PCIe mini Card
Touch Screen	5-wire resistive type with RS-232 interface	5-wire resistive type with RS-232 interface
LCD	- Resolution :1024x768 (XGA) - Brightness : 350 cd/m ² - Contrast Ratio : 700:1 - Viewing Angle (H-V):140/125 - Backlight MTBF : 50000hrs	- Resolution :1024x768 (XGA) - Brightness : 350 cd/m ² - Contrast Ratio : 700:1 - Viewing Angle (H-V):140/125 - Backlight MTBF : 50000hrs
Operating Temperature	0 °C~ 50°C.	
Storage Temperature	-20°C ~ 60°C.	
Vibration	-5~17Hz 0.1" double amplitude displacement, 17~640 Hz 1.5G acceleration peak to peak	
Shock	10G acceleration peak to peak. (11 ms)	
Relative Humidity	5%~ 95% @ 60°C, non-condensing	
Net / Gross Weight	7 Kg / 11 Kg	
Dimensions (W x H x D)	452 mm x 356 mm x 11 0 mm	
Power Supply	ATX Power - 180W, ACE-4518AP-RS - Input: 90 ~ 240VAC @ 50/60Hz - Output (max.): 3.3V@16.8A, 5V@12A, 12V@10A, - 12V@0.8A	ATX Power - 180W, ACE-4518AP-RS - Input: 90 ~ 240VAC @ 50/60Hz - Output (max.): 3.3V@16.8A, 5V@12A, 12V@10A, - 12V@0.8A
Front Panel Protection	IP 65 compliant	
Certificate	Meets CE, FCC	

Dimensions (Unit: mm)

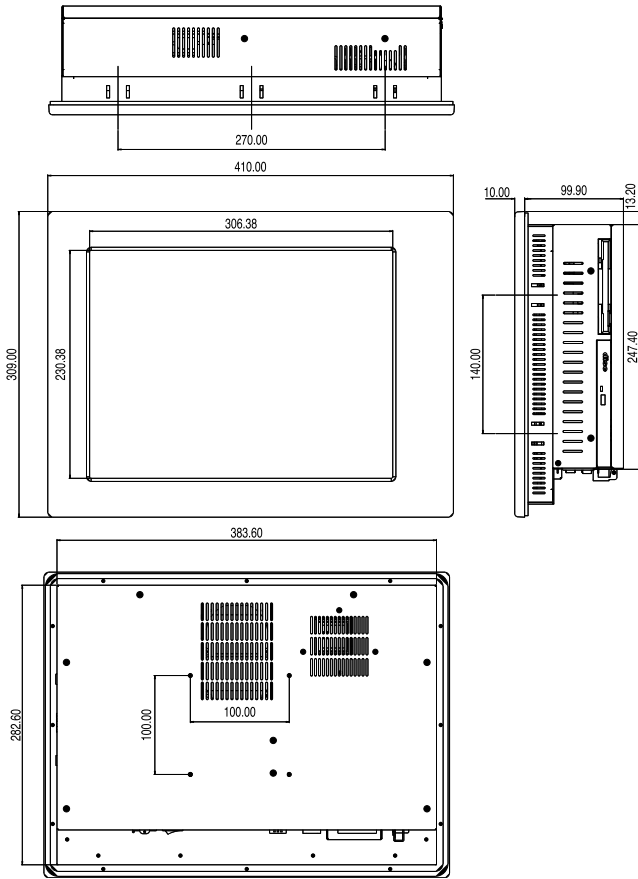

Anti-Shock Protection

Anti-shock design enhances protection performance of hard drives dramatically in terms of shock and vibration tests.

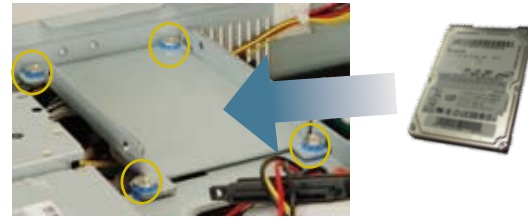

Shock Test

Vibration Test

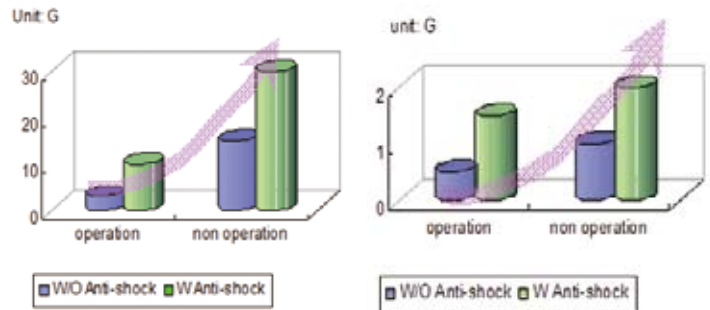

Packing List

Part Number	Description	Amount
32000-000002-RS	Power Cord	1
19100-000037-RS	CPU Cooler	1
19B00-000013-RS	CD-ROM Installation Kit	1
WK-150MS-R10	Wall Mounting Kit	1
PK-150M	Panel Mounting Kit	1
32200-014506-RS	HDD IDE Cable (44-pin + 2 x 40-pin)	1
32200-019201-RS	HDD IDE Cable (44-pin + 40-pin)	1
32000-077000-RS	HDD SATA Cable	1
19B00-000013-RS	FDD Installation Kit	1
41011-0397C0-00-RS	HDD Bracket	1
33100-000079-RS	Jumper Pack	1
19600-000078-RS	Screw Kit	1
	User Manual & Driver CD	1
	Touch Screen Driver CD / Touch Pen (for T-R model only)	1

IQ Mount Supporting List

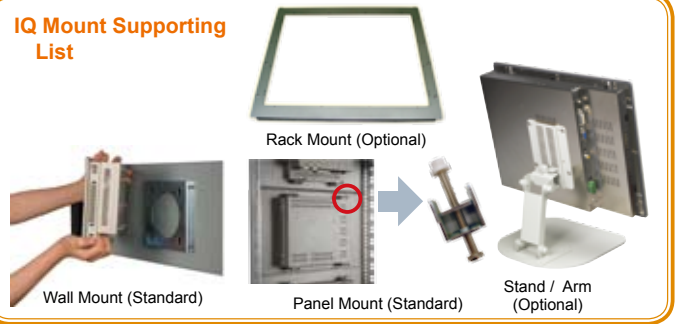

Power Supply Options

Type	Model No.	Watt	Remark
ATX AC-input	ACE-4518AP-RS	180W	
ATX DC-input	ACE-4520C-RS	200W	24VDC input

Options

RK-150MS-R10	Rack Mount kit
ARM-31-RS	LCD Monitor Arm
STAND-100-RS/STAND-210-RS	LCD Monitor Stand

Ordering Information

PPC-5150GS/8520-P4-28G/4518AP/T-R/1GB	15" 350 cd/m ² XGA TFT Panel PC with POS-8520, 2.8 GHz Intel® Pentium® 4 CPU, 1GB RAM, ACE-4518AP and touch screen Silver color, RoHS
PPC-5150GS/8520-P4-28G/4520C/T-R/1GB	15" 350 cd/m ² XGA TFT Panel PC with POS-8520, 2.8 GHz Intel® Pentium® 4 CPU, 1GB RAM, ACE-4520C and touch screen Silver color, RoHS
Core™2 Duo	
PPC-5150A/9455-PIV651/4518AP/T-R/1GB	15" 350 cd/m ² XGA TFT Panel PC with POS-9455, CPU Pentium® 4, 3.4Ghz, Cool Gray color, PSU ACE-4518AP and Touch screen, w/ 1GB DDR2 RAM, RoHS
PPC-5150A/9455-PIV651/4520C/T-R/1GB	15" 350 cd/m ² XGA TFT Panel PC with POS-9455, CPU Pentium® 4, 3.4Ghz, Cool Gray color, PSU ACE-4520C and Touch screen, w/ 1GB DDR2 RAM, RoHS