

# SRM-121/150GS *12.1"/15" Sunlight Readable TFT LCD Monitor*

**Fanless**

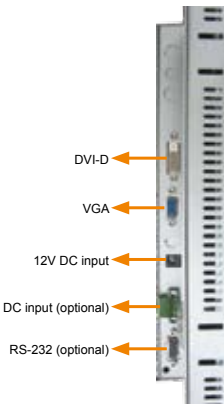

With Auto-Dimming Function



- Super High Brightness
- Auto-Dimming
- Anti-Reflection
- Wide Temperature
- IP65
- smart OSD

**Open Frame Available**



SRM-KIT

- Super High Brightness
- Auto-Dimming
- Anti-Reflection
- Wide Temperature
- smart OSD

## Features

1. 800 and 1000 nits super high brightness
2. 12.1" Anti-reflection Technology
3. 15' Anti-glare Technology
4. Nature Color Matrix (NCM) Technology
5. Innovative auto-dimming function
6. Wide Operating Temperature: -10°C ~ +60°C
7. IP 65 Compliant

## Specifications

| Model                           | SRM-121GS-R11                           | SRM-150GS-R11                          |
|---------------------------------|---|--|
|                                 | SRM-KIT121G-R11                         | SRM-KIT150G-R11                        |
| LCD Size                        | 12.1"                                   | 15"                                    |
| Max Resolution (H x V)          | 800 x 600 (SVGA)                        | 1024 x 768 (XGA)                       |
| Brightness (cd/m <sup>2</sup> ) | 1000                                    | 800                                    |
| Contrast Ratio                  | 700:1                                   | 600:1                                  |
| Display Color                   | 262k                                    | 262k                                   |
| View Angle (H/V)                | 130°/120°                               | 150°/110°                              |
| Pixel Pitch (mm)                | 0.3075                                  | 0.297                                  |
| Operating Temperature           | -10°C ~ +60°C                           |  |
| Storage Temperature             | -20°C ~ +70°C                           |  |
| Lamp Life Time                  | 50000hrs                                |  |
| Input Interface                 | Analog VGA , DVI-D                      |  |
| Front Frame                     | Aluminum                                |  |
| Chassis                         | Heavy-duty Steel                        |  |
| OSD Function                    | Yes                                     |  |
| Smart OSD                       | Yes                                     |  |
| Input Voltage                   | +12VDC/+ 9 ~ +36VDC(optional)<br>+12VDC |  |
| Mounting                        | Wall/Panel/Rack/Arm/Stand<br>Rack       |  |
| Front Panel Protection          | IP65 Compliant<br>N/A                   |  |
| Power Consumption               | 25W                                     | 30W                                    |
| Net Weight                      | 3.3kgs                                  | 6kgs                                   |
| Dimension (W x H x D mm)        | 340 x 260 x 58<br>316 x 224.4 x 47.9    | 410 x 309 x 65.2<br>364.1 x 262.5 x 46 |

## Super High Brightness

Typical high brightness monitors usually have more than six CCFLs, but the IEI SRM monitors have super high brightness with only four CCFLs. IEI SRM panels are still readable in bright sunlight with fewer backlights and thereby not increasing power consumption or producing extra heat.

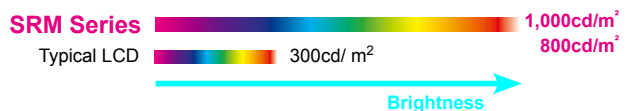

## Wide Temperature Range

Extended IEI environment testing is performed to ensure the SRM series continue to function properly over its entire services life in a wide working temperature range of -10°C to +60°C in order to accommodate a diverse industrial applications such as outdoor kiosks in winter and summer.

Conventional Operation: 0°C~50°C



## Superior fanless design and low power consumption

SRM models are fanless and therefore use less power and are more silent than conventional high brightness monitors that generally use several high-speed cooling fans. SRM models use between 25W and 30W of power compared to the 40W to 50W used by conventional high-brightness monitors

### Natural Color Matrix (NCM) Technology

POS terminals and kiosks often display advertisements and colorful images, the colors of which must remain vivid and faithful to the original.

The IEI SRM monitor with NCM optimization technology prevents this difference by separating color data and luminance components while controlling individual display colors for optimized performance.

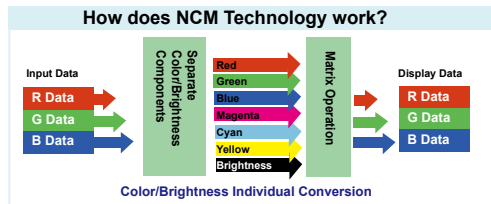
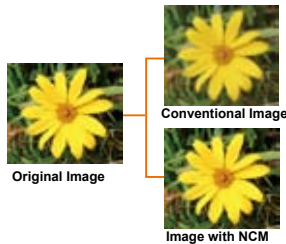

### Low Reflection through Anti-Reflection Technology



Outdoor applications in daylight or other bright environments require technology that can suppress surface reflection. The SRM-121GS has special AR (anti-reflection) surface treatment to prevent reflection, ensuring excellent visibility in daylight conditions.

#### How does Anti-Reflection Surface work?

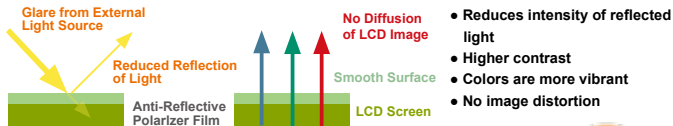

### Anti-glare Technology

The SRM-150GS is equipped with anti-glare glass. Anti-glare glass is produced by laminating a matte surface layer to the LCD screen. When light hits this rough surface, it bounces off at different angles which reduces the intensity of light reflecting off of the surface and hitting your eyes.

### Mounting Kits Information

|                   | SRM-121GS                     | SRM-150GS    |
|-------------------|-------------------------------|--------------|
| Panel Mount Kit   | PK-170M                       |              |
| Wall Mount Kit    | WK-190MS-R10                  |              |
| Rack Mount Kit    | RK-121MS-R10                  | RK-150MS-R10 |
| LCD Monitor Arm   | ARM-11                        | ARM-31       |
| LCD Monitor Stand | STAND-100-RS/<br>STAND-150-RS | STAND-210-RS |

### Packing List

|                          |   |
|--------------------------|---|
| 1 X AC Power Cable       | 1 X User Manual-CD ROM  |
| 1 X VGA Cable            | 1 X Power Cable for Terminal Block<br>( For M model only )                                |
| 1 X DVI cable            | 1 X Touch Screen RS-232 Cable / Touch Pen<br>/ Driver CD ROM<br>( For T-R model only )    |
| 1 X 45W AC Power Adapter | 1 X Touch Screen USB Cable / Touch Pen /<br>Driver CD ROM<br>( For USB / T-R model only ) |
| 1 X Screw set            |   |

### Innovative Auto-Dimming Function

IEI SRM series with auto-dimming function can adjust brightness according to ambient light, so that SRM series can job properly under different lamp house average, and outdoor environment. This function not only saves unnecessary brightness that strains eyes strained and makes you tire but also saves energy saving.

The SRM series auto-dimming default settings can be easily customized with the OSD menu to suit any environment.

#### Adjustable Backlight



#### Adjustable Ambient Brightness



### Ordering Information

Note: The smartOSD function is supported by revision 11 models and above

#### SRM-121GS

|                        |  |
|------------------------|--|
| SRM-121GS-R11/T-R      | 12.1" 1000cd/m <sup>2</sup> Sun Readable SVGA LCD Monitor, Aluminum Front Panel, Silver Color, w/VGA and DVI-D input, w/12.1" Touch Screen, RoHS                       |
| SRM-121GS-USB-R11/T-R  | 12.1" 1000cd/m <sup>2</sup> Sun Readable SVGA LCD Monitor, Aluminum Front Panel, Silver Color, w/VGA and DVI-D input, w/12.1" USB Touch Screen, RoHS                   |
| SRM-121GMS-R11/T-R     | 12.1" 1000cd/m <sup>2</sup> Sun Readable SVGA LCD Monitor, Aluminum Front Panel, Silver Color, w/VGA and DVI-D input, w/9~36V DC input, w/12.1" Touch Screen, RoHS     |
| SRM-121GMS-USB-R11/T-R | 12.1" 1000cd/m <sup>2</sup> Sun Readable SVGA LCD Monitor, Aluminum Front Panel, Silver Color, w/VGA and DVI-D input, w/9~36V DC input, w/12.1" USB Touch Screen, RoHS |
| SRM-KIT121G-R11        | 12.1" 1000 cd/m <sup>2</sup> Sun Rdadable SVGA TFT LCD kit, VGA and DVI-D input, 9~36 V DC input,RoHS  |

#### SRM-150GS

|                        |  |
|------------------------|--|
| SRM-150GS-R11/T-R      | 15" 800cd/m <sup>2</sup> Sun Readable XGA LCD Monitor, Aluminum Front Panel, Silver Color, w/VGA and DVI-D input, w/15" Touch Screen, RoHS                       |
| SRM-150GS-USB-R11/T-R  | 15" 800cd/m <sup>2</sup> Sun Readable XGA LCD Monitor, Aluminum Front Panel, Silver Color, w/VGA and DVI-D input, w/15" USB Touch Screen, RoHS                   |
| SRM-150GMS-R11/T-R     | 15" 800cd/m <sup>2</sup> Sun Readable XGA LCD Monitor, Aluminum Front Panel, Silver Color, w/VGA and DVI-D input, w/9~36V DC input, w/15" Touch Screen, RoHS     |
| SRM-150GMS-USB-R11/T-R | 15" 800cd/m <sup>2</sup> Sun Readable XGA LCD Monitor, Aluminum Front Panel, Silver Color, w/VGA and DVI-D input, w/9~36V DC input, w/15" USB Touch Screen, RoHS |
| SRM-KIT150G-R11        | 15" 800 cd/m <sup>2</sup> Sun Rdadable XGA TFT LCD kit, VGA and DVI-D input, 9~36 V DC input,RoHS  |

DM / TDM / SRM Series Dimensions

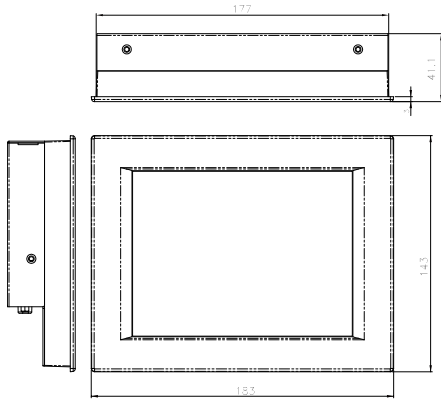

DM-65GS

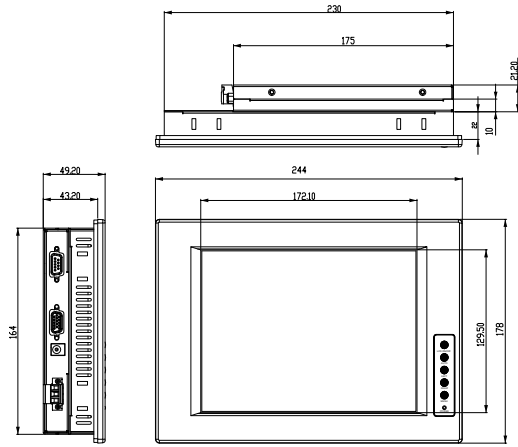

DM-84GS

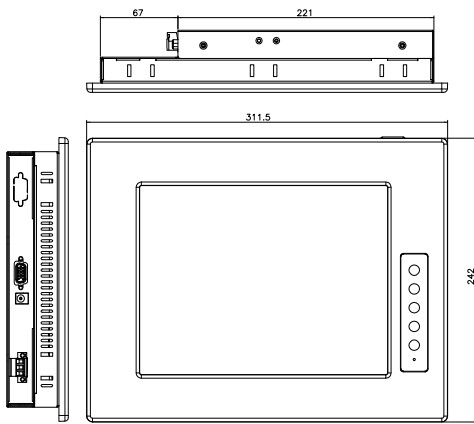

DM-104GS

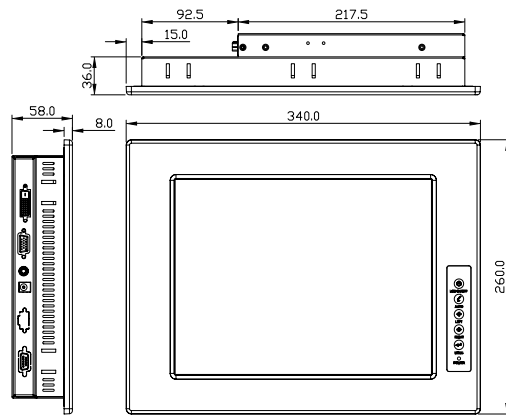

DM-121GS

TDM-121GMS

SRM-121GS

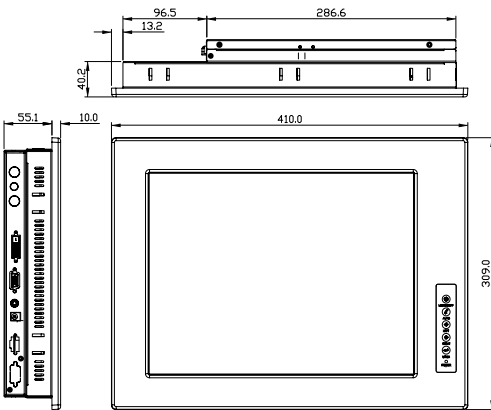

DM-150GS

TDM-150GMS

SRM-150GS

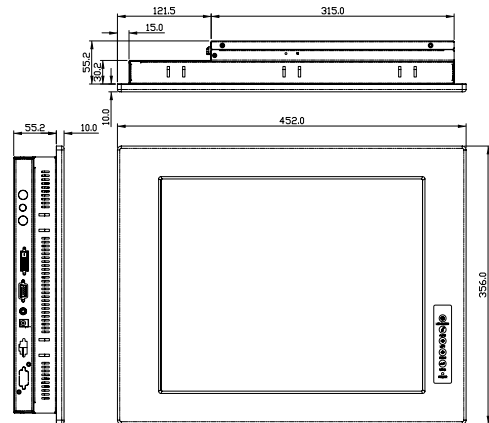

DM-170GS

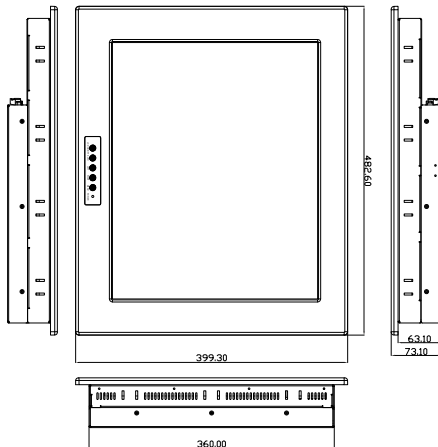

DM-190GS

