

SRM-121/150

12.1"/15" Sunlight Readable TFT LCD Monitor

1
Automation

Fanless

SRM Series



With Auto-Dimming Function

- Super High Brightness
- Auto-Dimming
- Anti-Reflection
- Wide Temperature
- IP65
- smart OSD**

+9~36V DC input
RS-232 12V DC input VGA DVI-D



I/O PORT

2
Point of Service

3
Digital Signage

4
RISC-based Solutions

5
Medical Solutions

Open Frame

SRM-KIT Series

New 9-36V DC Input



Prolongable OSD Cable with Auto-Dimming Function

- Super High Brightness
- Auto-Dimming
- Anti-Reflection
- Wide Temperature
- smart OSD**

Features

1. 800 and 1000nits Super high brightness
2. Superior Fanless Design
3. 12.1" anti-reflection technology reduces light reflection and high transmission rate to prevent light loss or distortion
4. Adjustable auto-dimming function
5. Wide Operating Temperature: -10°C~+60°C
6. OSD lock secures your settings
7. IEI patent software OSD support

Specifications

Model	SRM-121GS	SRM-121XA	SRM-150GS
	SRM-KIT121G	SRM-KIT121XA	SRM-KIT150G
LCD Size	12.1"	12.1"	15"
Max Resolution (H x V)	800 x 600 (SVGA)	1024 x 768 (XGA)	1024 x 768 (XGA)
Brightness (cd/m ²)	1000	1000	800
Contrast Ratio	700:1	700:1	600:1
Display Color	262k	262k	262k
View Angle (H/V)	130°/120°	120°/120°	150°/110°
Pixel Pitch (mm)	0.3075	0.240	0.297
Operating Temperature	-10°C ~ +60°C		
Storage Temperature	-20°C ~ +70°C		
Lamp Life Time	50000hrs		
Input Interface	Analog VGA , DVI-D		
Front Frame	Aluminum		
Chassis	Heavy-duty Steel		
OSD Function	Yes		
Smart OSD	Yes		
Input Voltage	+ 9 ~ +36VDC (Optional for G Model) +12VDC		
Mounting	Wall/Panel/Rack/Arm/Stand Rack		
Front Panel Protection	IP65 Compliant N/A		
Power Consumption	25W	30W	
Net Weight	3.3kgs	6kgs	
Dimension (W x H x D mm)	340 x 260 x 58	410 x 309 x 65.2	
	316 x 224.4 x 47.9	364.1 x 262.5 x 46	

Super High Brightness

Typical high brightness monitors usually have more than six CCFLs, but the IEI SRM monitors have super high brightness with only four CCFLs. IEI SRM panels are still readable in bright sunlight with fewer backlights and thereby not increasing power consumption or producing extra heat.

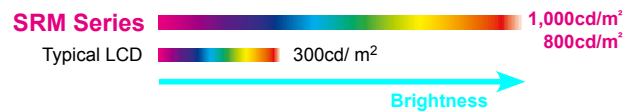

Wide Temperature Range

Extended IEI environment testing is performed to ensure the SRM series continue to function properly over its entire services life in a wide working temperature range of -10°C to +60°C in order to accommodate a diverse industrial applications such as outdoor kiosks in winter and summer.

Conventional Operation:
0°C~50°C



Superior fanless design and low power consumption

SRM models are fanless and therefore use less power and are more silent than conventional high brightness monitors that generally use several high-speed cooling fans. SRM models use between 25W and 30W of power compared to the 40W to 50W used by conventional high-brightness monitors

Innovative Auto-Dimming Function

IEI SRM series with auto-dimming function can adjust brightness according to ambient light, so that SRM series can job properly under different lamp house average, and outdoor environment. This function not only saves unnecessary brightness that strains eyes strained and makes you tire but also saves energy saving.

The SRM series auto-dimming default settings can be easily customized with the OSD menu to suit any environment.

Adjustable Backlight



Adjustable Ambient Brightness



Anti-Reflection Technology

SRM-121GS

Outdoor applications in daylight or other bright environments require technology that can suppress surface reflection. The SRM-121GS has special AR (anti-reflection) surface treatment to prevent reflection, ensuring excellent visibility in daylight conditions.

How does Anti-Reflection Surface work?

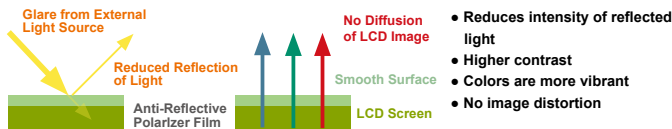

12.1" XGA High Resolution

SRM-121XA series supports higher resolutions and smaller pixel pitches (0.24mm versus 0.24mm) to deliver great displays. Higher resolution of a high-density display allows more viewable content so that the user does not have to scroll as much to view the entire spreadsheet.

12.1" SVGA Screen Capture 12.1" XGA Screen Capture



XGA Higher Resolution

- Present vivid and fine display quality
- Increase viewable content

Mounting Kits Information

	SRM-121GS	SRM-150GS
Panel Mount Kit	PK-170M	
Wall Mount Kit	WK-190MS-R10	
Rack Mount Kit	RK-121MS-R10	RK-150MS-R10
LCD Monitor Arm	ARM-11	ARM-31
LCD Monitor Stand	STAND-100-RS	STAND-210-RS

Packing List

Description	Part Number	Specification
Power Cord	32000-000002-RS	1750mm (EU or US, Which type of cord is shipped depends on the contry)
VGA Cable	32000-036200-RS	1800mm
45W Power Adapter	63000-UP0451E12P81L-RS	1800mm
POWER CABLE	32100-041001-RS	400mm (For SRM M Models)
	32000-123800-RS	400mm (For SRM-KIT M Models)
DVI Cable	32000-086600-RS	1800mm (For SRM Models)
RS-232 Cable for Touch	32000-000098-RS	(For SRM RS-232 Touch Models)
USB Cable for Touch	32000-045801-RS	(For SRM USB Touch Models)
Touch Kit/Touch Pen		(For SRM Touch Screen Models)
User's Manual CD-ROM		

Natural Color Matrix (NCM) Technology

POS terminals and kiosks often display advertisements and colorful images, the colors of which must remain vivid and faithful to the original.

The IEI SRM monitor with NCM optimization technology prevents this difference by separating color data and luminance components while controlling individual display colors for optimized performance.

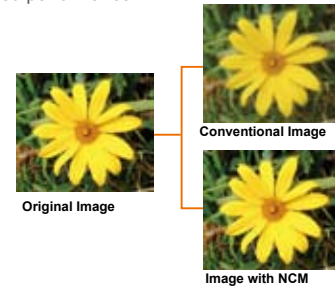

Ordering Information

12.1" SVGA SRM Series

	Model	Description
12V DC	SRM-121GS-R11/T-R	12.1" 1000cd/m ² Sun Readable SVGA LCD Monitor, Aluminum Front Panel, Silver Color, w/VGA and DVI-D input, w/12.1" Touch Screen, RoHS
	SRM-121GS-USB-R11/T-R	12.1" 1000cd/m ² Sun Readable SVGA LCD Monitor, Aluminum Front Panel, Silver Color, w/VGA and DVI-D input, w/12.1" USB Touch Screen, RoHS
9~36V DC	SRM-121GMS-R11/T-R	12.1" 1000cd/m ² Sun Readable SVGA LCD Monitor, Aluminum Front Panel, Silver Color, w/VGA and DVI-D input, w/9~36V DC input , w/12.1" Touch Screen, RoHS
	SRM-121GMS-USB-R11/T-R	12.1" 1000cd/m ² Sun Readable SVGA LCD Monitor, Aluminum Front Panel, Silver Color, w/VGA and DVI-D input, w/9~36V DC input, w/12.1" USB Touch Screen, RoHS

12.1" XGA SRM Series

	Model	Description
12V DC	SRM-121XA-R10/T-R	12.1" 1000cd/m ² Sun Readable XGA LCD Monitor, Aluminum Front Panel, Silver Color, w/VGA and DVI-D input, w/12.1" Touch Screen, RoHS
	SRM-121XA-USB-R10/T-R	12.1" 1000cd/m ² Sun Readable XGA LCD Monitor, Aluminum Front Panel, Silver Color, w/VGA and DVI-D input, w/12.1" USB Touch Screen, RoHS
9~36V DC	SRM-121XMA-R10/T-R	12.1" 1000cd/m ² Sun Readable XGA LCD Monitor, Aluminum Front Panel, Silver Color, w/VGA and DVI-D input, w/9~36V DC input, w/12.1" Touch Screen, RoHS
	SRM-121XMA-USB-R10/T-R	12.1" 1000cd/m ² Sun Readable XGA LCD Monitor, Aluminum Front Panel, Silver Color, w/VGA and DVI-D input, w/9~36V DC input, /12.1" USB Touch Screen, RoHS

15" XGA SRM Series

	Model	Description
12V DC	SRM-150GS-R11/T-R	15" 800cd/m ² Sun Readable XGA LCD Monitor, Aluminum Front Panel, Silver Color, w/VGA and DVI-D input, w/15" Touch Screen, RoHS
	SRM-150GS-USB-R11/T-R	15" 800cd/m ² Sun Readable XGA LCD Monitor, Aluminum Front Panel, Silver Color, w/VGA and DVI-D input, w/15" USB Touch Screen, RoHS
9~36V DC	SRM-150GMS-R11/T-R	15" 800cd/m ² Sun Readable XGA LCD Monitor, Aluminum Front Panel, Silver Color, w/VGA and DVI-D input, w/9~36V DC input , w/15" Touch Screen, RoHS
	SRM-150GMS-USB-R11/T-R	15" 800cd/m ² Sun Readable XGA LCD Monitor, Aluminum Front Panel, Silver Color, w/VGA and DVI-D input, w/9~36V DC input , w/15" USB Touch Screen, RoHS

12.1"/15" SRM-KIT Series

	Model	Description
12V DC	SRM-KIT121G-R11	12.1" 1000 cd/m ² Sun Rdadable SVGA TFT LCD kit, VGA and DVI-D input, RoHS
	SRM-KIT121XA-R10	12.1" 1000 cd/m ² Sun Rdadable XGA TFT LCD kit, VGA and DVI-D input, RoHS
	SRM-KIT150G-R11	15" 800 cd/m ² Sun Rdadable XGA TFT LCD kit, VGA and DVI-D input, RoHS
9~36V DC	SRM-KIT121GM-R10	12.1" 1000 cd/m ² Sun Readable SVGA TFT LCD kit, VGA and DVI-D input, w/9-36V DC input, RoHS
	SRM-KIT121XMA-R10	12.1" 1000 cd/m ² Sun Readable XGA TFT LCD kit, VGA and DVI-D input, w/9-36V DC input, RoHS
	SRM-150GM-R10	15" 800 cd/m ² Sun Readable XGA TFT LCD kit, VGA and DVI-D input, w/9-36V DC input, RoHS

Dimensions

SRM-121GS

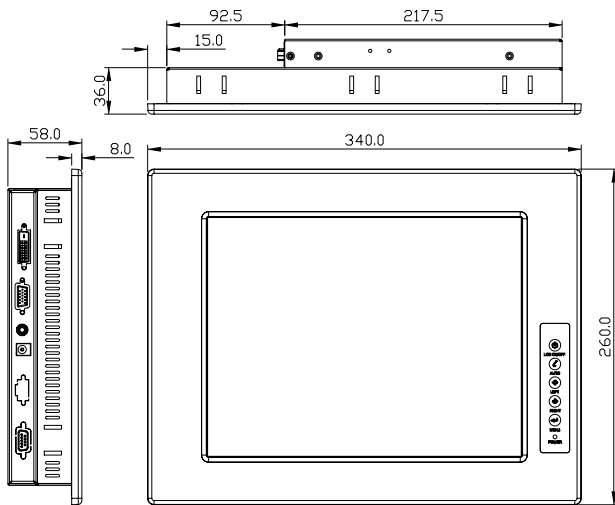

SRM-150GS

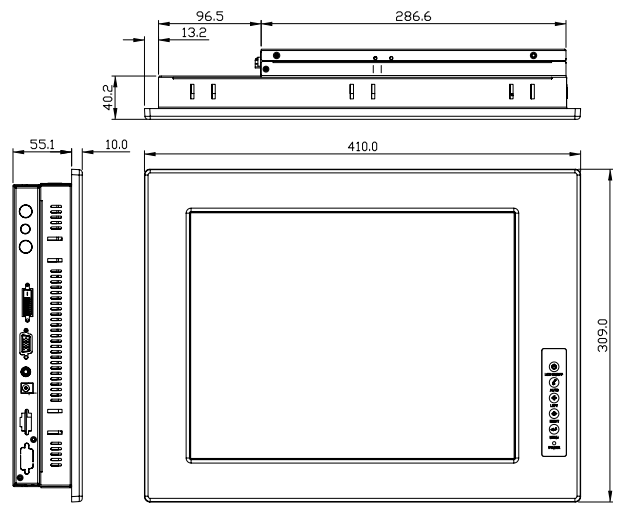

SRM-KIT121G

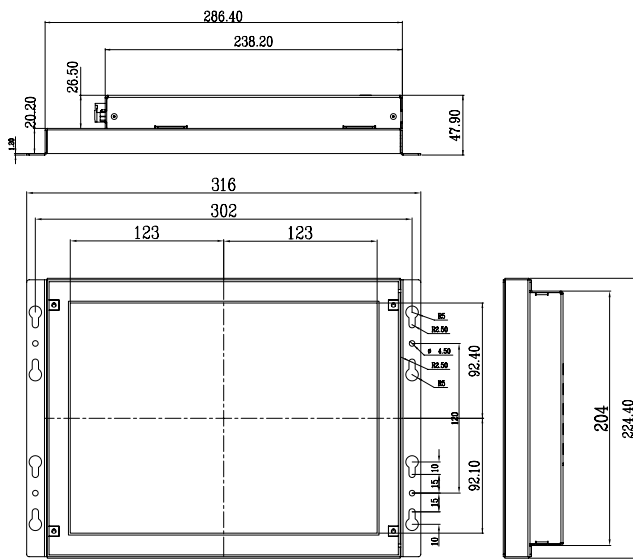

SRM-KIT150G

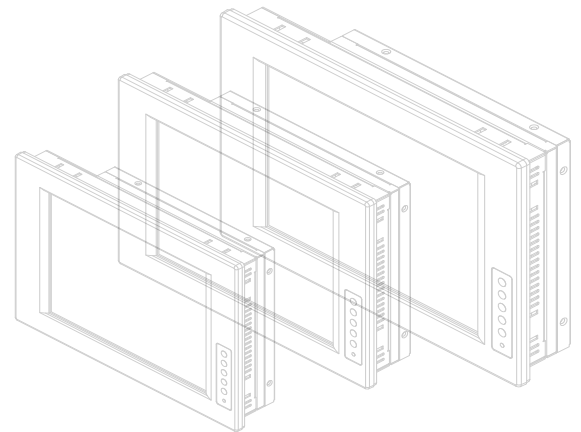
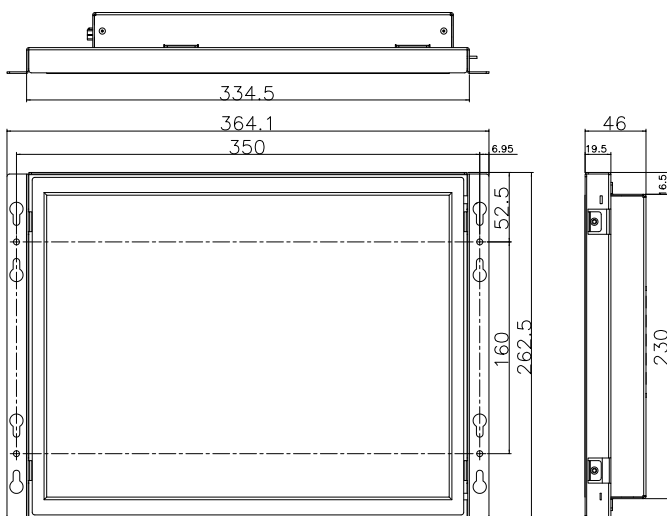

1
Automation

2
Point of Service

3
Digital Signage

4
RISC-based Solutions

5
Medical Solutions